

Pulse control timer BA 7864, EO 7864 minitimer

0227773

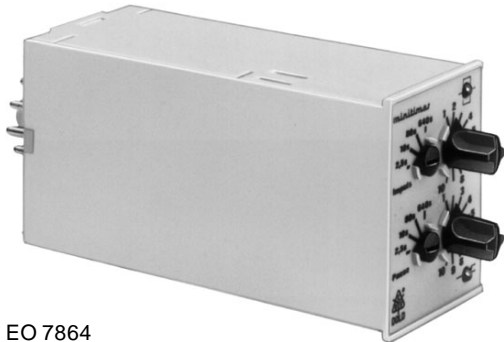

BA 7864



EO 7864



EO 7864 with front frame ET 4048-3

- According to DIN EN 61 812-1
- Time range up to 32 h
- Separate setting of impulse- and space time
- For impulse- and space time 4 time ranges each
- Repeat accuracy $< \pm 0,5 \%$
- Setting on relative scale
- Dual-voltage-version
- Programmable for start with impulse or space
- LED indication for operation and contact position
- BA 7864 available with remote potentiometer contact Z1-Z2, Z3-Z4
- EO 7864 with 11-pole socket according to IEC 67-1-18 a
- Available with 1 or 2 changeover contacts, or semiconductor output (BA7864)
- BA 7864: width 45 mm
- EO 7864: front size 35 x 48 mm

Approvals and marking



Application

Time dependent controls

Indication

red LED: on when operating voltage applied
green LED: on when output relay activated

Notes

By an external bridge via terminals 6-7 of the plug-in-socket the EO 7864 can be programmed for the start with space.

The BA 7864.- - starts with impulse, whereas the special version of the device BA 7864.- -/010 starts with space. For the variants BA7864.81 and BA 7864.81/010 a remote setting of the impulse- or space time is possible via two external variable resistors.

Function diagram

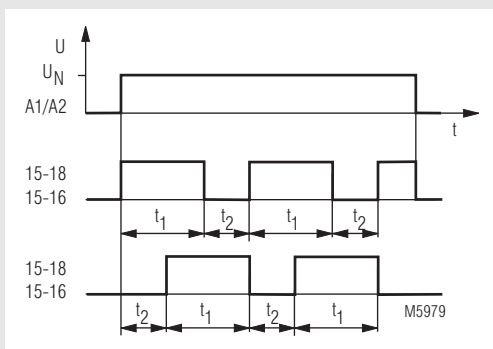

Circuit diagrams

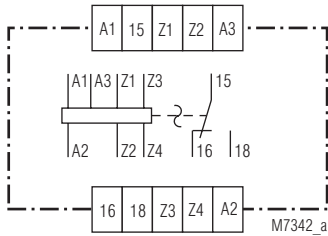

BA 7864.81

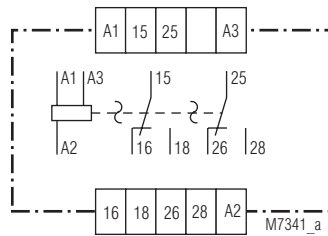

BA 7864.82

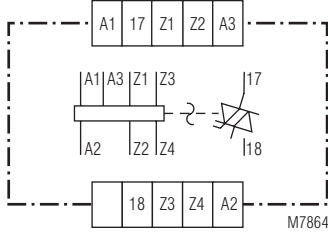

BA 7864.91

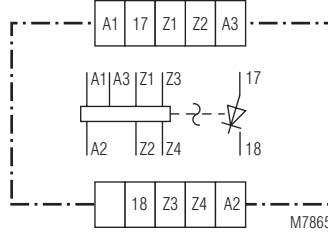

BA 7864.95

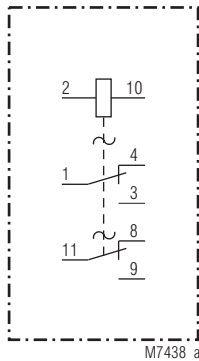

EO 7864.82
(single-voltage version)

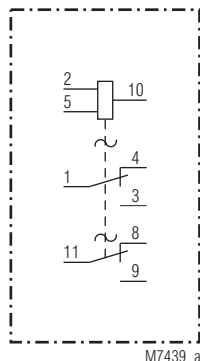

EO 7864.82
(dual-voltage version)

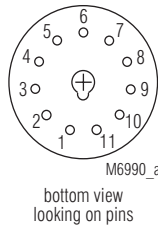

M6990_a
bottom view
looking on pins

Technical data

Voltage range

AC/DC 24 V and AC/DC 42 V: AC and DC (residual ripple $\leq 20\%$)
0,8 ... 1,2 U_N
DC (residual ripple = 48 %)
0,8 ... 1,1 U_N

AC 110 ... 127 V and
AC 220 ... 240 V:

Nominal consumption:
AC 24 V 0,7 VA
AC 42 V 1,2 VA
AC 110 V 2,5 VA
AC 230 V 5 VA
DC 24 V 0,6 W
DC 42 V 1,2 W

Nominal frequency:

50 / 60 Hz

Relay output

Contacts

BA 7864.81: 1 changeover contact
BA 7864.82: 2 changeover contacts
EO 7864.81: 1 changeover contact
EO 7864.82: 2 changeover contacts
Thermal current I_{th} : 5 A

Switching capacity

to AC 15: 5 A / AC 230 V EN 60 947-5-1
EN 60 947-5-1

Electrical life

to AC 15 at 3 A, AC 230 V: 1,5 x 10⁵ switching cycles

Short circuit strength

max. fuse rating: 5 A gL EN 60 947-5-1
Mechanical life: > 30 x 10⁶ switching cycles

Solid state output

BA 7864.91: Triac
Switching voltage: AC 12 ... 275 V
Switching current: 4 A
BA 7864.95: Transistor
Switching voltage: DC 15 ... 30 V
Switching current: 5 A

General data

Operating mode: Continuous operation
Temperature range: - 20 ... + 60 °C

Clearance and creepage distances

overvoltage category /
contamination level: 4 kV / 2 IEC 60 664-1

EMC

Electrostatic discharge: 8 kV (air) EN 61 000-4-2
HF irradiation: 10 V/m EN 61 000-4-3
Fast transients: 2 kV EN 61 000-4-4
Surge voltages: 1 kV EN 61 000-4-5
Interference suppression: Limit value class B EN 55 011
Degree of protection: Housing: IP 40 EN 60 529
Terminals: IP 20 EN 60 529

Housing:

Thermoplast with V0-behaviour
according to UL subject 94

Vibration resistance:

Amplitude 0,35 mm
frequency 10 ... 55 Hz EN 60 068-2-6
20 / 060 / 04 EN 60 068-1

Climate resistance:

Wire connection:

BA 7864: 2 x 2,5 mm² solid or
2 x 1,5 mm² stranded wire with sleeve
DIN 46 288-1/-2/-3/-4
EO 7864: via plug-in-socket suitable to the
11-pole socket according to
IEC 67-1-18 a
Wire fixing: Flat terminals with self-lifting
clamping piece EN 60 999

Weight

BA 7864: 200 g
EO 7864: 110 g

Technical data

Time circuit

Time range:

impulse and space separately adjustable
in 4 steps:
0,25 ... 2,5 s or 0,25 ... 2,5 min
1 ... 10 s 1 ... 10 min
8 ... 80 s 8 ... 80 min
64 ... 640 s 64 ... 640 min

or 0,75 ... 7,5 min
3 ... 30 min
24 ... 240 min
3,2 ... 32 h

other combinations of these time ranges
for impulse or space, on demand.
for impulse and space separately
infinite on relative scale (1:10)

Time setting:

Recovery time:

Operate time:

Release time:

Remote setting

BA 7864.81:

AD 3 1 M Ω
(2 pieces, for impulse- and space time)

Repeat accuracy:

Voltage influence:

Temperature range:

< $\pm 0,5\%$ of the scale max. value
< 1 % over the whole voltage range
< 0,1 % / K

Input

Nominal voltage U_N :

AC/DC 24, 42 V
AC/DC 24¹⁾ + AC 110 ... 127 V²⁾
AC/DC 24¹⁾ + AC 220 ... 240 V²⁾
¹⁾ to terminals A3-A2 or terminals 5-10
²⁾ to terminals A1-A2 or terminals 2-10

Technical data

Dimensions

Width x height x depth

BA 7864:	45 x 73 x 133 mm
EO 7864:	35 x 48 x 109 mm
Front-panel cut-out	
EO 7864:	45 ^{+0,6} x 45 ^{+0,6} mm

Standard types

BA 7864.81	AC/DC 24 V + AC 220 ... 240 V	640 s On / 640 s Off
Article number:	0032194	stock item
• Output:	1 changeover contact	
• Nominal voltage U_N :	AC/DC 24 V + AC 220 ... 240 V	
• Time setting for impulse and space:	0,25 ... 640 s	
• Width:	45 mm	
EO 7864.82	AC/DC 24 V + AC 220 ... 240 V	640 m On / 640 m Off
Article number:	0032222	stock item
• Output:	2 changeover contacts	
• Nominal voltage U_N :	AC/DC 24 V + AC 220 ... 240 V	
• Time setting for impulse and space:	0,25 ... 640 m	
• Front size:	35 x 48 mm	

Variants

BA 7864. __ /010:	start with space
BA 7864.81/100:	programmable, start with space, when X3, X4 bridged

Ordering examples for Variants

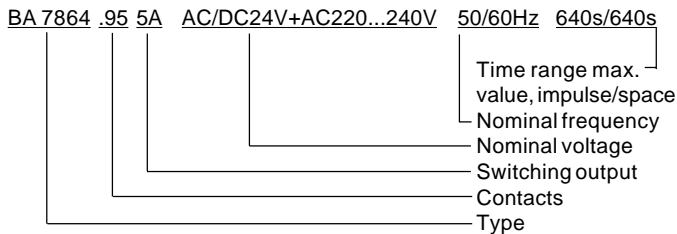
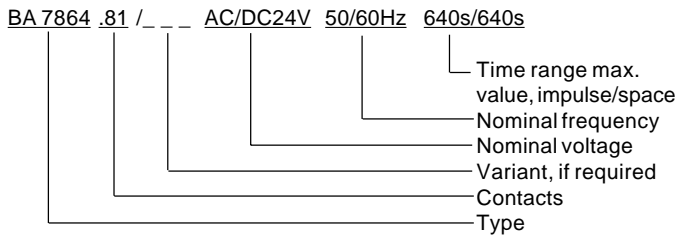

Accessories

for BA 7864.81:
AD 3:

External variable resistor 1 M Ω

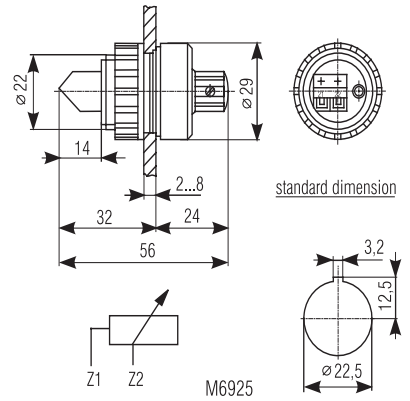

for EO-version:
for DIN rail mounting:
ET 4048-21:
ET 4048-22:
for flush mounting:
ET 4048-13:
ET 4048-3:

plug-in socket without fixing clamp
plug-in socket with fixing clamp

plug-in adapter
front frame